





Coupe AA

-  Béton banché pour mur
-  Béton armé pour chaînage
-  Béton armé pour radier
-  Béton armé pour bêche
-  Béton de propreté
-  Terrain d'assise

Légende de la coupe

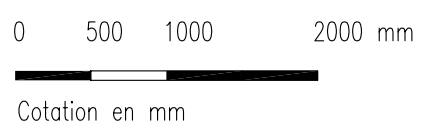
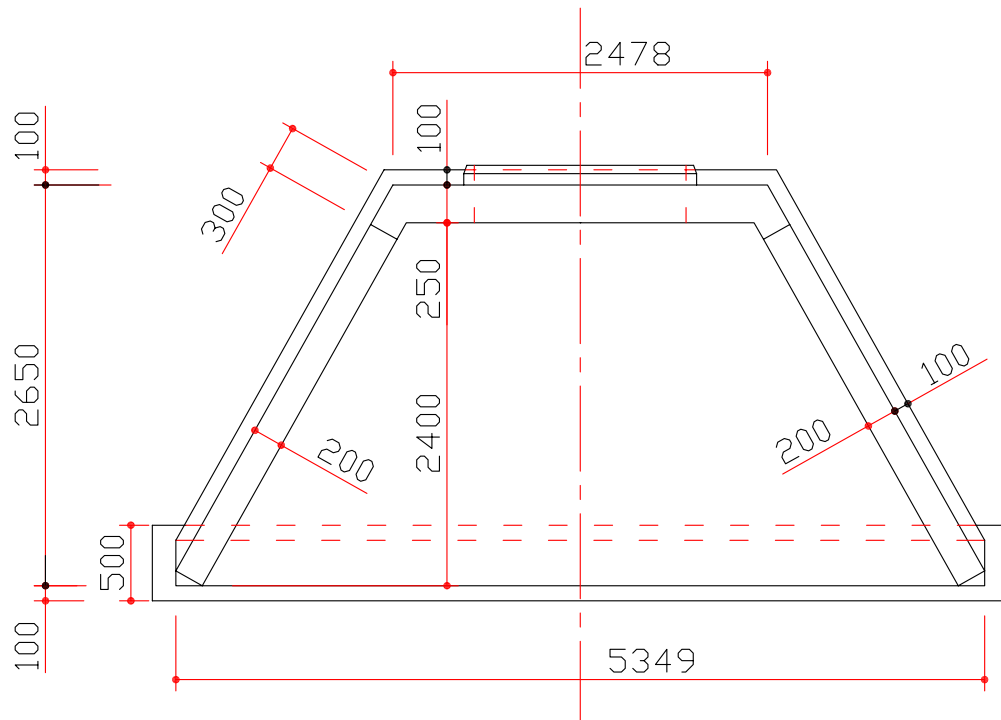

Reproduction interdite

DAO avec Autocad ®	Editions EYROLLES
Tête d'ouvrage hydraulique	Date : 8 mars 2004
	Ech : 1/50 (0.02)